

GB Instruction for use

# POWERTEX

## Lever Hoist PLH-S2



User Manual



## POWERTEX Lever Hoist PLH-S2 0,25 – 9 ton Instruction for use (GB) (Original instructions)

Read through these user instructions before using the lever hoist. Improper operation may lead to hazardous situations.

### General safety provisions

- Only to be used by trained operator.
- Do not use in explosive or corrosive environment.
- Temperature range: -10°C up to +50°C.
- Check the function of the lever hoist before use. See “Daily checks” on page 4.
- Do not exceed the maximum load.
- Full function of the brake system can only be secured at a minimum load of 30 kg for capacities (WLL) up to 1 ton, and for capacities (WLL) above 1 ton, the minimum load to be greater than 3% of the rated capacity (WLL).
- Handle the lever hoist with care. Do not throw the hoist about or let it fall to the ground.
- Do not use the lever hoist for welding work where it is exposed to welding spatter or current.
- The lever hoist block must not be used for lifting persons.

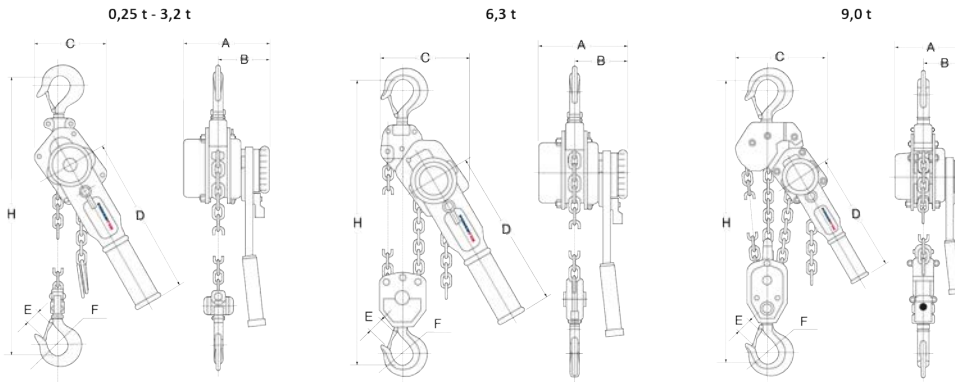

Fig. 1 dimensioned sketch

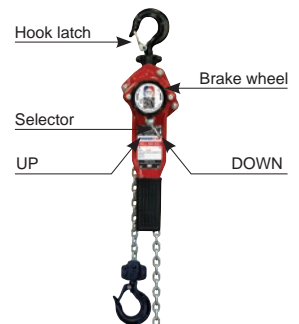

Fig. 2 Description

### Data

Model	WLL ton	Hand force max. (kg)	Load chain (mm)	Number of falls	Weight* (kg)
PLH-S2/250KG	0,25	28,2	4,0 x 12,0	1	2,7
PLH-S2/500KG	0,5	24,8	5,0 x 15,0	1	5,2
PLH-S2/800KG	0,8	26,5	5,6 x 17,0	1	6,6
PLH-S2/1600KG	1,6	29,5	7,1 x 21,0	1	11,0
PLH-S2/3200KG	3,2	33,5	10,0 x 28,0	1	19,9
PLH-S2/6300KG	6,3	37,0	10,0 x 28,0	2	24,6
PLH-S2/9000KG	9	42,0	10,0 x 28,0	3	50,0
PLH-S2OLP/500KG	0,5	24,8	5,0 x 15,0	1	5,2
PLH-S2OLP/800KG	0,8	26,5	5,6 x 17,0	1	6,6
PLH-S2OLP/1600KG	1,6	29,5	7,1 x 21,0	1	11,0
PLH-S2OLP/3200KG	3,2	33,5	10,0 x 28,0	1	19,9
PLH-S2OLP/6300KG	6,3	37,0	10,0 x 28,0	2	24,6
PLH-S2OLP/9000KG	9	42,0	10,0 x 28,0	3	50,0

OLP = Overload Protection. \* Weight for hoist with 1,5 m lift.

### Dimensions

WLL ton	A (mm)	B (mm)	C (mm)	D (mm)	E (mm)	F (mm)	H min. (mm)
0,25	100	70	86	163	20	31	235
0,5	150	90	118	253	22	32	310
0,8	158	98	132	273	26	36	340
1,6	185	111	145	378	29	43	400
3,2	212	124	198	418	37	50	520
6,3	212	124	230	418	43	53	640
9	212	124	338	418	44	67	730

Safety factor: 4:1.

Dynamic test coefficient: WLL x 1,5.

Generally according to EN 13157.

## Function

The load hook is raised or lowered by operating the lever handle.  
The load will remain where it is when the lever handle is released because of the effective reaction brake.  
Max hand force need to be respected to avoid overloading of the hoist.

The Over Load Protection (OLP) versions are additionally equipped with an overload protection device that will limit the force that can be applied using the ratchet handle.

If the OLP device is activated the lever handle will rotate but the hoist will not continue to lift, only lowering is possible.

The overload protection device is adjusted in the factory to approx. 1,3 x WLL and the device normally don't need to be adjusted

## Pulling through the unloaded chain (see Fig. 2)

Make sure the chain is unloaded and set the selector to neutral position (N). Pull the chain through by hand to the desired position.



**Warning!** If the selector is in position UP or DOWN when the chain is pulled, the lever may rotate like a propeller, which could be dangerous.



**Warning!** If the lever hoist is used on a load which is too light, the brake function will not engage. The load must be at least 3% of maximum load. For example a minimum load of 30 kg is necessary to engage the brake on a 1 tonne hoist. For lightloads choose a smaller lever hoist.

If it proves impossible to pull the chain through despite the selector being in neutral, it may be necessary to release the brake first, by turning the brake wheel anti-clockwise. If this does not help, set the selector to position DOWN, load the chain slightly and jerk the lever in clockwise direction. Then try again without load but with the selector in neutral.

## Suspension of lever hoist

Make sure the hoist is suspended from an eye, shackle or similar with sufficient bearing capacity. With the chain tightened, both hooks must be in line (Fig. 3a).



**NB!** Neither hoist, hooks nor chain may be subjected to bending stresses (Figs. 3b and c and Fig. 4).

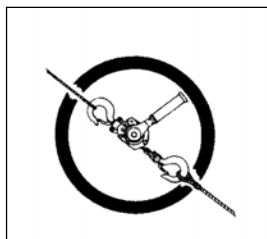

Fig 3 a

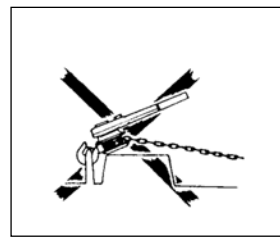

Fig 3 b

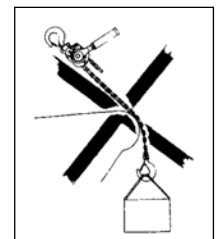

Fig 3 c

## Attachment of loads

Check the equipment well before use. Improper attachment of loads can be highly dangerous (see Figs. 4 a–e).



Only use straps and slings of sufficient load capacity. Make sure the load is not anchored to the floor/ground or is otherwise fixed before making the lift.

## Lifting/pulling

With the selector in position UP, operate the lever to tighten the chain. Check for safety before lifting the load to the desired position. If the load is too light to be lifted, hold onto the brake wheel so you hear the snapping sound. You will then be able to lift the load with just one hand. If the lever is released while lifting, the load will be held in its current position by the reaction brake. The lever hoist can also be used for pulling and fixing loads.



Fig 4 a

The sling is applying load to the hook tip!

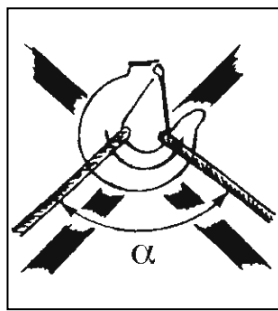

Fig 4 b

Excessive top angle on sling!  
 $\alpha$  max. 60°

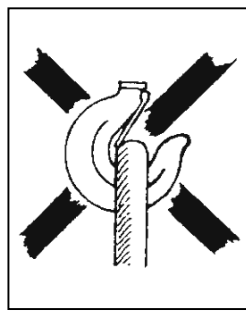

Fig 4 c

Hook latch obstructed!

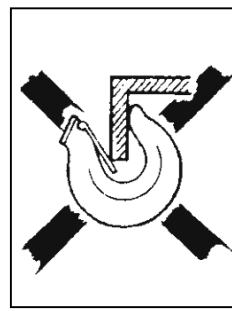

Fig 4 d

Hook tip subject to additional bending stress!

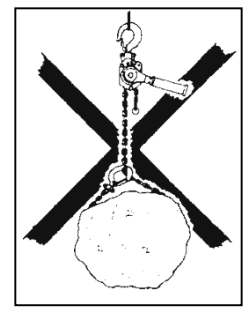

Fig 4 e

Load chain must not be used as a sling!

## Further safety precautions

- Never lengthen the lifting lever with a pipe or similar. Use only hand power on the lever. If the load seems too heavy, use a bigger lever hoist or reduce the load.
- Make sure no-one stands beneath a hanging load.
- Do not raise or lower so far that the load hook or the stop eye hits the block housing.
- Do not set the selector to neutral under load.
- The block must not be subjected to dynamic stresses, for example where a load connected to the block is launched from a height.
- Do not leave a block with a suspended load unattended.

## Lowering

With the selector in DOWN position, operate the lever to lower the load. Wait until the chain has been completely freed of load before moving the selector to Neutral (N) to rapidly pull out the chain. (See "Pulling through the unloaded chain").

**Warning:** Do not overload the brake by prolonged lowering. It may cause brake function to fail.

## Multiple lifting

Multiple lifting presents special risks. This is when two or perhaps more hoists are used simultaneously for the same load. Danger to persons and material damage can arise due to dynamic stresses and uneven load distribution causing individual hoists to become overloaded. A competent person with experience in multiple lifting must therefore supervise this type of lifting tasks.

The total weight of the target object and its load distribution must be known or calculated.

For a variety of reasons, the centre of gravity can be difficult to determine, and thus so will the distribution of the load each hoist must bear. In cases where heavy, bulky loads must be handled and it is not possible to estimate all factors correctly, the max working load limit (WLL) of each hoist must be reduced by at least 25%.

## Daily checks

After every working day on which the lever hoist has been used, the following should be checked:

- Is the lever hoist deformed or otherwise damaged? Are any parts missing?
- Is any deformation or other damage visible on the suspension device (eye, shackle, bolt or similar)?
- Are the hooks intact or have any hooks opened? Are the hook latches correct and functional?
- The selector must work without problems.
- Wipe down the lever hoist and oil the chain as required.
- The chain must be undamaged, i.e. no signs of wear and no deformed or otherwise damaged links.
- The chain must not be kinked or twisted. With 2-fall lever hoists (6,3 t), there is a risk of the chain twisting if the bottom hook assembly ends up looped through the chain sling – usually during refitting or moving the hoist between work stations. See Fig 5.
- The chain stop must free of deformation or other damage.
- The brake function must be intact.

In the event of faults or failures, the hoist must be repaired and carefully checked by a specialist before reuse.

## Continuous maintenance - lubrication

Oil the hook latches and bearings. Grease the pawl and ratchet and also the gear. Lubrication must be sparingly and carefully applied so no grease gets on the brake disk. Oil the chain for longer life.

## Periodic checks

Periodic checks are normally carried out yearly to detect and remedy any faults. If required (e.g. high frequency of use), more frequent checks may be carried out. See "Checklist for periodic checks". Measure hooks and chain to detect any changes in shape.

## Hook checks (see fig 6 and Table 2)

Opening dimension E on the hooks is important. A hook with too large a maximum dimension has been exposed to overloading or overheating. It therefore does not have the necessary load capacity. The hooks may also have been exposed to long-term wear (dimension K).

Hooks must be discarded and replaced if:

- the maximum E value is exceeded (according to Table 2)
  - the minimum K value falls short (according to Table 2)
  - the hook is cracked, deformed or otherwise damaged.
- Defective hooks must be replaced before using the lever hoist again!

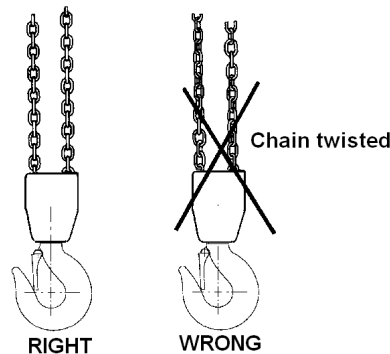

Fig. 5 The chain must not be twisted

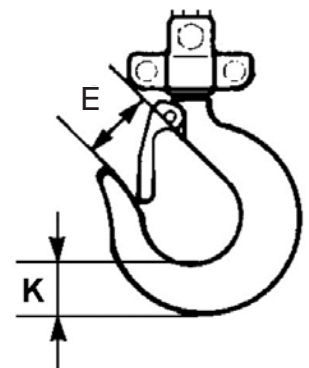

Fig. 6 Load hook

Table 2 Hook dimensions

Max. load tonnes	0,25	0,5	0,8	1,6	3,2	6,3	9
Model	PLH-S2	PLH-S2	PLH-S2	PLH-S2	PLH-S2	PLH-S2	PLH-S2
Dimension E nominal mm	24	25,5	30	33	41,5	47	55
Dimension E max. mm	26,4	28,0	33	36,3	45,6	51,7	60,5
Dimension K nominal mm	15	19	25	29	39	44,5	62
Dimension K min mm	13,5	17,1	22,5	26	35,1	40,0	55,8

## Check measurement of chain (See Fig. 7 and table 3)

Inspect the chain over its whole length to detect any deformed or otherwise damaged links. Make a check measurement of suspect links. Measure the worn areas Also, every 300 mm (normally), take check measurements of the internal length of 5 links (pitch dimension 5xP according to Table 3).

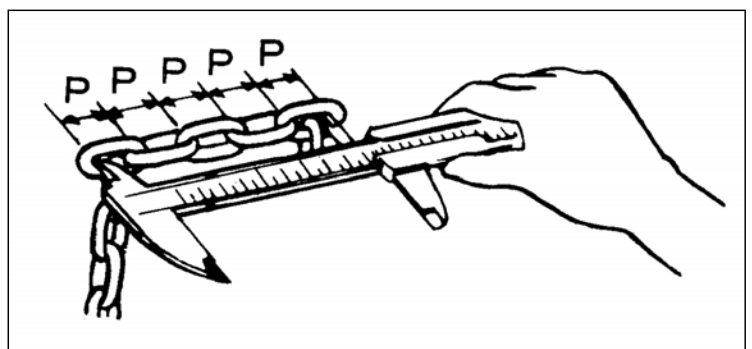

Fig 7 Checking chain dimension

**Table 3** Chain dimensions

<b>Max. load tonnes</b>	<b>0,25</b>	<b>0,5</b>	<b>0,8</b>	<b>1,6</b>	<b>3,2</b>	<b>6,3</b>	<b>9</b>
Model	PLH-S2	PLH-S2	PLH-S2	PLH-S2	PLH-S2	PLH-S2	PLH-S2
Link diameter nominal mm	4,0	5,0	5,6	7,1	10,0	10,0	10,0
Link diameter min. mm	3,6	4,5	5,0	6,4	9,0	9,0	9,0
Pitch dimension (5xP) nominal mm	60,0	75,0	85,0	105,0	140,0	140,0	140,0
Pitch dimension (5xP) max. mm	61,8	77,2	92,7	108,1	144,2	144,2	144,2

The chain must be discarded and replaced if:

- cracks are detected on any link
- any link is deformed or otherwise damaged
- The minimum value of any link's diameter falls short
- the maximum value of the pitch dimension is exceeded at any point
- the chain is damaged by overheating or has been affected by weld splatter

Chains must **not** be repaired – they must be replaced by a new original chain. If it is desired to lengthen the chain, it must be replaced by a new and longer chain.

Replacement of the chain shall be performed professionally by an authorized repairer and the chain must meet the requirements stated in the standard EN 818-7, Grade T from the following manufacturers: Chaineries Limousines, Pewag, Thiele or Rud.

### Repairs

The lever hoist must not be modified. Repairs must be carried out by specialists. Damaged parts must only be replaced with original Powertex parts. Order them through your dealer.

### EC Declaration of conformity

SCM Citra OY

Asessorinkatu 3-7

20780 Kaarina, Finland

[www.powertex-products.com](http://www.powertex-products.com)

hereby declares that the POWERTEX product as described above is in compliance with EC Machinery Directive 2006/42/EC & EN 13157.

### UK Declaration of conformity

SCM Citra OY

Asessorinkatu 3-7

20780 Kaarina, Finland

[www.powertex-products.com](http://www.powertex-products.com)

hereby declares that the POWERTEX product as described above is in compliance with the Supply of Machinery (Safety) Regulations 2008 & BS EN 13157.

## Checklist for periodic checks (normally yearly – more frequently if necessary)

Daily	Yearly	Inspection items	Inspection method	Note
<b>Labels</b>				
X	X	Rating plate	Visual	If the plate is hard to read - replace it
<b>Function</b>				
X	X	Raising and lowering function	Test without load	A low snapping noise should be audible
-	X	Raising and lowering function	Test with 125% of rated load over a distance of min. 300 mm.	The lever runs easily. Load chain sprocket and chain work well together Brake works. The chain does not twist or tangle Hand pulling on the lever feels even
X	X	Selector	Operation	Easy to reset
X	X	Pulling through	Operation	Function
<b>Hooks</b>				
X -	- X	Hook opening	Visual Measurement	Looks normal See Fig. 6 and Table 2
X	X	Deformation	Visual	No visible deformation
X	X	Hook bearing	Visual	No abnormal play
X -	- X	Wear, cracks, deformation and corrosion	Visual Measurement	No visible damage See Fig. 6 and Table 2
X	X	Hook latches	Visual	Works, spring undamaged
<b>Chain</b>				
X -	- X	Pitch	Visual Measurement	Looks normal. Measure in case of doubt. See Fig. 7 and Table 3
X -	- X	Wear	Visual Measurement	Looks problem-free. Measure in case of doubt. See Fig. 7 and Table 3
X	X	Deformation	Visual	No deformation. Measure in case of doubt.
X	X	Cracks etc.	Visual	No cracks
X	X	Rust	Visual	No rust
<b>Housing</b>				
X	X	Housing	Visual	No deformation and no rust
-	X	Operating lever	Visual	No deformation
-	X	Load chain sprocket	Visual after dismantling	No serious wear or cracks. No fractures or deformation
-	X	Bearings	Visual, testing	No damage, smooth running
-	X	Gears	Visual after dismantling	No serious wear or fractures
X	X	Chain stop	Visual	Must be free of deformation
<b>Screws</b>				
X	X	Screws, nuts, rivets, cotters etc.	Visual	Must not be missing. Tighten loose items. Replace as necessary
<b>Brake</b>				
-	X	Brake disk	Visual	Replace if worn
-	X	Brake screw	Visual	No serious wear
-	X	Pawl and ratchet	Visual	Replace worn parts. Carefully lubricate with grease.

**POWERTEX Lever Hoist PLH-S2 – Parts 0,25 t**

When ordering parts, specify model, WLL, pos number and the quantity needed.

When ordering chain, also specify lifting height.

If the load chain has been damaged or worn out the load sheave probably has to be replaced.

**POWERTEX Lever Hoist 0,25 t**

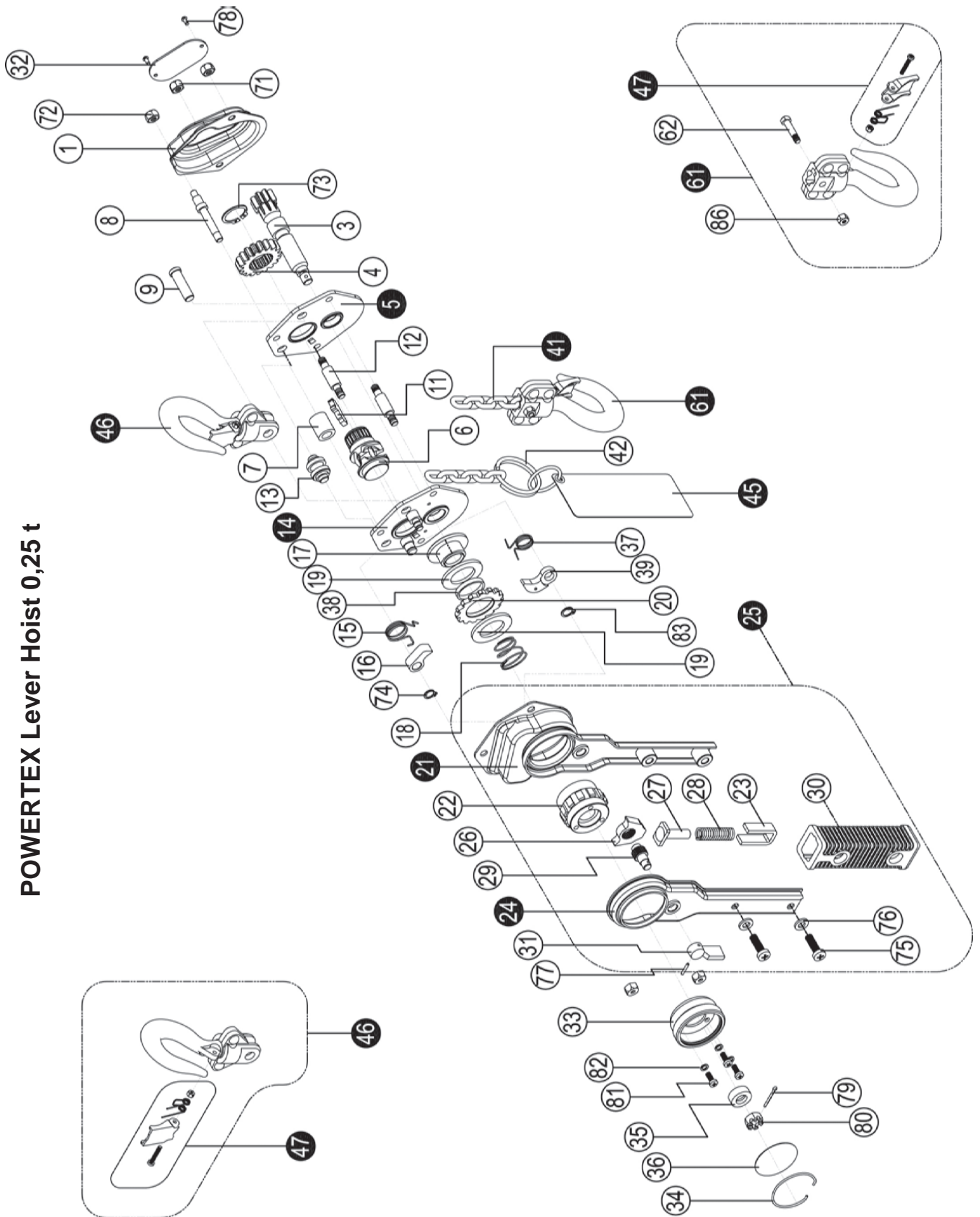

**Parts list 0,25 t**

Pos	Description
1	Gear cover
3	Drive shaft
4	Splined gear
5	Right side plate assy
6	Load chain sprocket
7	Bushing
8	Stay bolt B
9	Pin for tophook
10	Bushing B
11	Chain stripper
12	Stay bolt A
13	Guide roller
14	Left side plate assy
15	Pawl spring B
16	Pawl
17	Disk hub
18	Free spring
19	Friction disk
20	Ratchet disk
21	Left lever handle assy
22	Change over gear
23	Spring seat
24	Right lever handle assy
25	Handle assy
26	Change over pawl
27	Spring shaft
28	Change over spring
29	Selector shaft
30	Handle rubber grip
31	Selector lever
32	Name plate
33	Hand wheel
34	Steel wire retainer
35	Step washer
36	Hand wheel name plate
37	Pawl spring
38	Washer
39	Pawl
41	Load Chain
42	Chain ring
45	Warning plate assy
46	Top hook assy
47	Safety latch assy
61	Bottom hook assy
62	Bottom hook pin
71	Nylon lock nut
72	Nylon lock nut
73	Circlip for shaft
74	Circlip for shaft
75	Cross head screw
76	Flat washer
77	Spring pin
78	Name plate rivet
79	Split pin
80	Hexagon nut
81	Cross head screw
82	Light spring washer
83	Cliclip for shaft
86	Nylon lock nut



**POWERTEX Lever Hoist PLH-S2 – Parts 0,5 – 6,3 t**

When ordering parts, specify model, WLL, pos number and the quantity needed.

When ordering chain, also specify lifting height.

If the load chain has been damaged or worn out the load sheave probably has to be replaced.

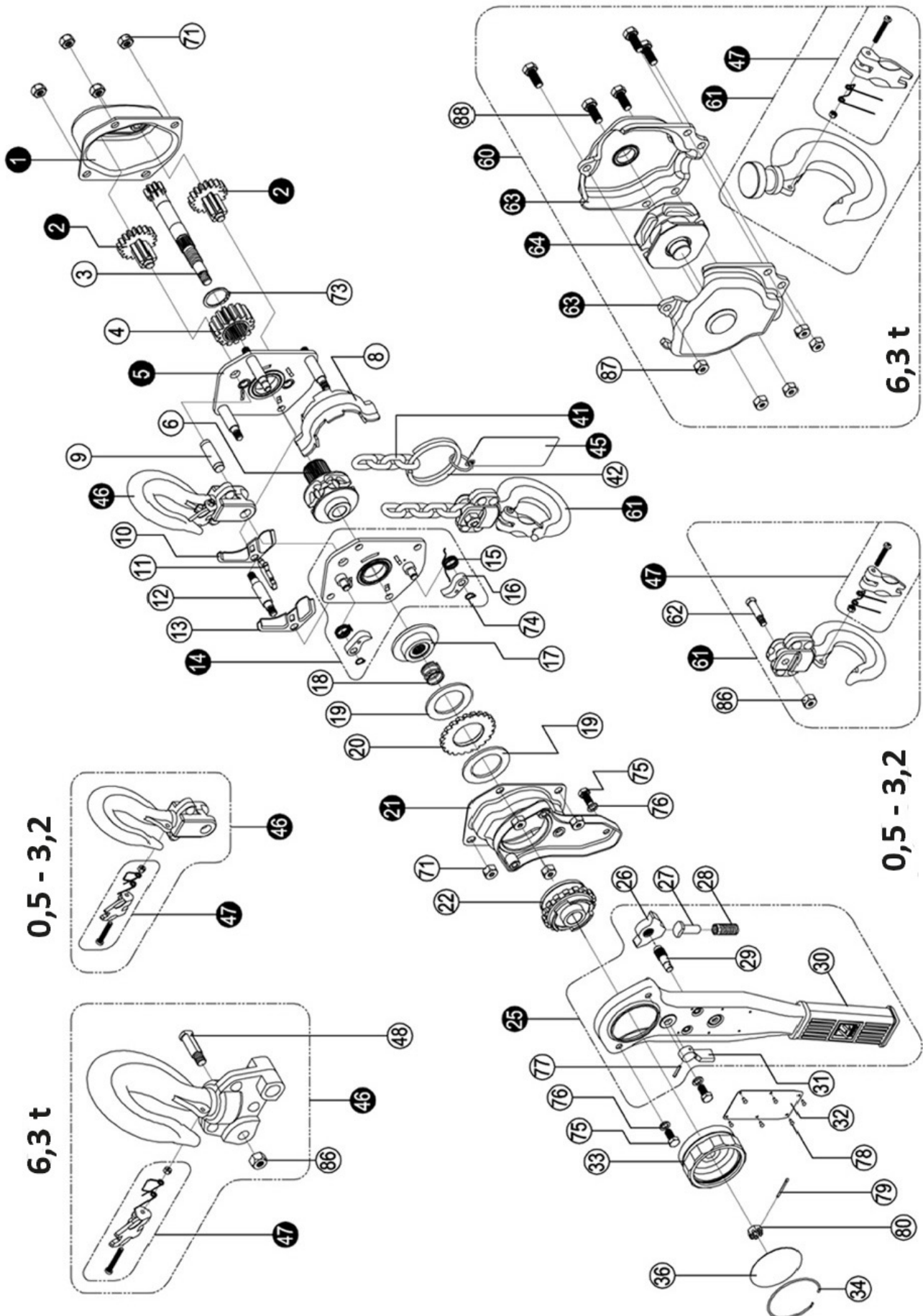

**Parts list 0,5 – 6,3 t**

Pos	Description
1	Gear cover assy
2	Disc gear assy
3	Drive shaft
4	Splined gear
5	Right side plate assy
6	Load chain sprocket
8	Chain guide
9	Top hook shaft
10	Chain leader A
11	Chain stripper
12	Stay bolt B
13	Chain leader B
14	Left side plate assy
15	Pawl spring
16	Pawl
17	Brake seat
18	Free spring
19	Friction plate
20	Ratchet wheel
21	Ratchet wheel cover assy
22	Changeover ratchet wheel
25	Handle assy
26	Changeover pawl
27	Spring pin
28	Changeover spring
29	Selector plate shaft
30	Handle rubber grip
31	Selector plate
32	Name plate
33	Hand wheel
34	Steel wire retainer
36	Hand wheel name plate
41	Load Chain
42	Chain ring
45	Warning plate assy
46	Top hook assy
47	Safety latch assy
48	Top hook pin
60	Bottom hook assy
61	Hook assy
62	Bottom hook pin
63	Bottom hook connector assy
64	Idler sheave assy
71	Metal lock nut
73	Circlip
74	Circlip
75	Bolt
76	Light spring washer
77	Spring pin
78	Name plate rivet
79	Split pin
80	Hexagon nut
86	Metal lock nut
87	Metal lock nut
88	Bolt

**POWERTEX Lever Hoist PLH-S2 – Parts 9 t**

When ordering parts, specify model, WLL, pos number and the quantity needed.

When ordering chain, also specify lifting height.

If the load chain has been damaged or worn out the load sheave probably has to be replaced.

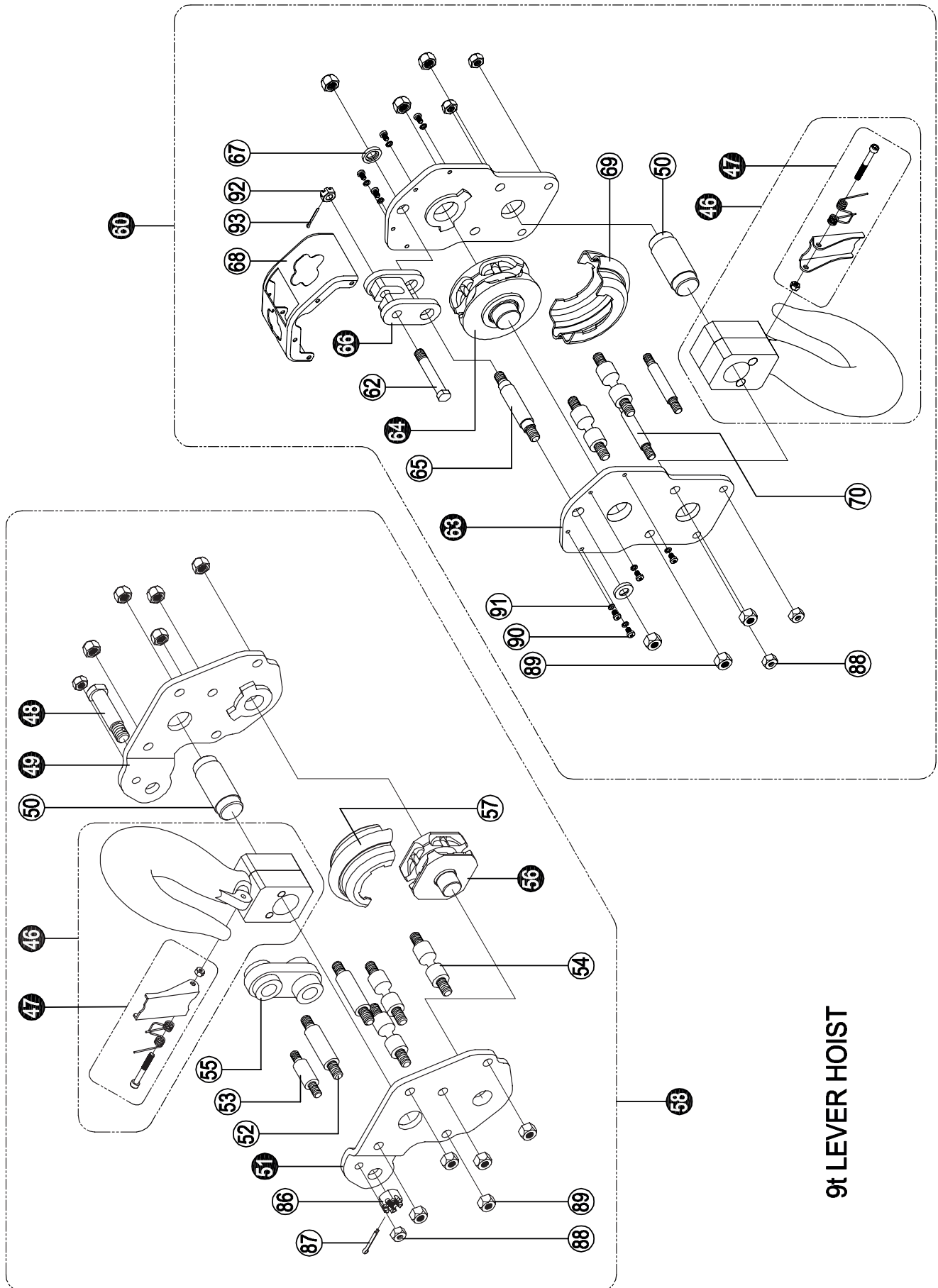

**9t LEVER HOIST**

## Parts list 9 t

Pos	Description
1	Gear cover assy
2	Disc gear assy
3	Drive shaft
4	Splined gear
5	Right side plate assy
6	Load chain sprocket
8	Chain guide
9	Top hook shaft
10	Chain leader A
11	Chain stripper
12	Stay bolt B
13	Chain leader B
14	Left side plate assy
15	Pawl spring
16	Pawl
17	Brake seat
18	Free spring
19	Friction plate
20	Ratchet wheel
21	Ratchet wheel cover assy
22	Changeover ratchet wheel
25	Handle assy
26	Changeover pawl
27	Spring pin
28	Changeover spring
29	Selector plate shaft
30	Handle rubber grip
31	Selector plate
32	Name plate
33	Hand wheel
34	Steel wire retainer
36	Hand wheel name plate
41	Load Chain 10x28
42	Chain ring
45	Warning plate assy
46	Hook assy
47	Safety latch assy

48	Top hook pin
49	Beam for hook connector- Right
50	Hook shaft
51	Beam for hook connector- Left
52	Stay bolt A
53	Short stay bolt
54	Stay bolt B
55	Hanger plate
56	Upper idler sheave assy
57	Cover for idler sheave
58	Top hook assy
60	Bottom hook assy
62	Bottom hook pin
63	Plate for hook connector
64	Bottom idler sheave assy
65	Bolt
66	Hanger plate
67	Spacer washer
68	Protection cover
69	Cover for idler sheave
70	Bolt
71	Metal lock nut M12
73	Circlip 42
74	Circlip 9
75	Hexagonal head bolt M8x14
76	Light spring washer
77	Spring pin 3x18
78	Name plate rivet 2.5x6
79	Split pin 2.5x25
80	Hexagon recess nut M12
86	Hexagon recess nut M16
87	Split pin 4x28
88	Metal lock nut M10
89	Metal lock nut M12
90	Cross head screw M5x10
91	Light spring washer 5
92	Hexagon recess nut M12
93	Split pin 2.5x25

## CertMax+

The CertMax+ system is a unique leading edge certification management system which is ideal for managing a single asset or large equipment portfolio across multiple sites. Designed by the Lifting Solutions Group, to deliver optimum asset integrity, quality assurance and traceability, the system also improves safety and risk management levels.



## Marking

The POWERTEX Lever Hoist is equipped with a RFID (Radio-Frequency Identification) tag, which is a small electronic device, that consist of a small chip and an antenna. It provides a unique identifier for the product.



The POWERTEX Lever Hoist is **CE and UKCA** marked

Standard: EN 13157



## Warning tag

The warning tag shows some specific and important situations, in which you must pay special attention, when using POWERTEX Chain Blocks and Lever Hoists.



## User Manuals

You can always find the valid and updated User Manuals on the web. The manual is updated continuously and valid only in the latest version.

**NB!** The English version is the Original instruction.

The manual is available as a download under the following link:  
[www.powertex-products.com/manuals](http://www.powertex-products.com/manuals)



### Product compliance and conformity

SCM Citra OY  
 Asessorinkatu 3-7  
 20780 Kaarina  
 Finland  
[www.powertex-products.com](http://www.powertex-products.com)



**POWERTEX**

---

[www.powertex-products.com](http://www.powertex-products.com)